

microTimer User's Manual

A subminiature digital timer for multistage ignition or recovery deployment.

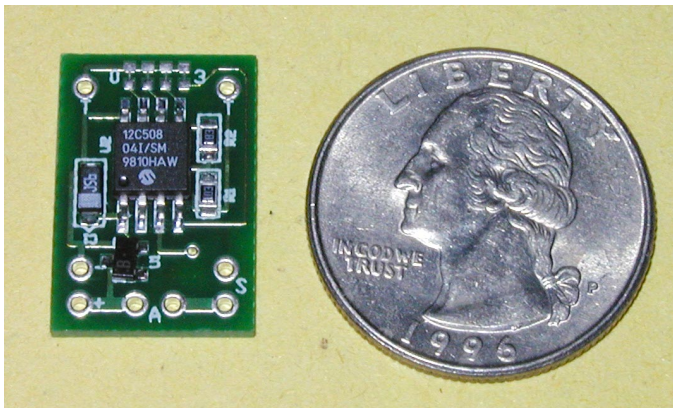

PerfectFlite

15 Pray Street
Amherst, MA 01002
Voice (413) 549-3444
FAX (413) 549-1548

URL: www.perfectflite.com
Sales: sales@perfectflite.com
Support: support@perfectflite.com

Congratulations on your purchase of the new microTimer staging/ejection timer. Please read these instructions carefully before attempting to use the timer to insure safe and successful operation.

Your microTimer can be used for several purposes:

- o **Ignition of upper stages in multi-stage rockets.** The timer is activated at launch via a pull-pin or breakwire. After a predetermined interval coincident with booster motor burnout, power is provided to the next stage's ignition system. This method allows for staging of composite propellant motors which are not suitable for conventional "burn-through" staging techniques. The small size of the microTimer allow it to be used with black powder engines as well, providing an alternative to the recently-discontinued Estes B6-0 motors.
- o **Electronic deployment of recovery devices.** The timer is activated at launch via a pull-pin or breakwire. After a predetermined interval power is provided to an ejection charge to deploy the parachute. The timer provides a wide range of precise, repeatable delay times not attainable with most motors' built-in delays. Additionally, since the motor ejection charge is not used, the problem of delay "burn-by" causing premature ejection is eliminated.
- o **Redundant deployment of recovery devices.** The timer is activated at launch via a pull-pin or breakwire. An altimeter or accelerometer provides the primary recovery system deployment, and the timer ignites an additional ejection charge several seconds "late" as a backup in case of altimeter/accelerometer failure.

Operation

When power is applied to the timer it sits idle until it is triggered, at which point the timed interval begins. The green LED on the bottom of the board provides visual indication of continuity through the igniter.

The timer is triggered by opening the normally closed (shorted) connection between the two Trigger leads (labeled "T" on the board). This is typically done by having a very thin "breakwire" connecting these leads together, with a stronger piece of wire looped around the breakwire and fixed to the ground. When the rocket leaves the pad, tension from the heavier wire snaps the breakwire, causing an open circuit condition.

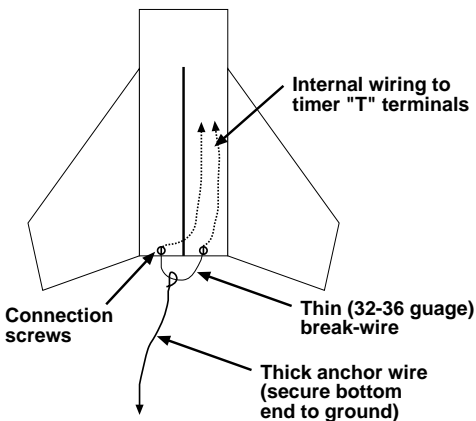

Another option is to use a pull-pin on a wire attached to the ground, which is then inserted into a switch such as the normally open contacts of a miniature phone jack.

As a safety precaution, if the contacts are broken momentarily and then reconnected due to wind-induced switch bounce, etc. the timer will remain in idle mode and the interval will not commence. After being triggered, the timer counts down until its preset time period has elapsed, at which point the MOSFET switch turns on. The Arming leads (labeled "A" on the board) must also be connected together in order for power to be supplied to the igniter. Power is switched off after a period of 2 seconds to protect the timer and battery in the event of igniter short-circuit.

Getting to Know Your microTimer

The photos below show the location of the wiring connections, continuity LED, and delay-setting jumper pads. Details on setting the delay time are given in the following section.

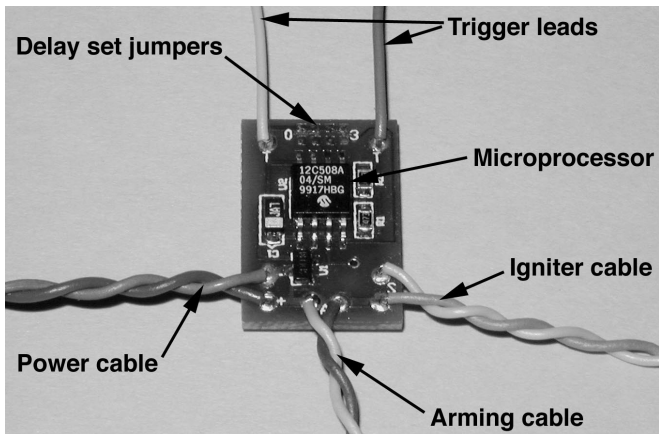

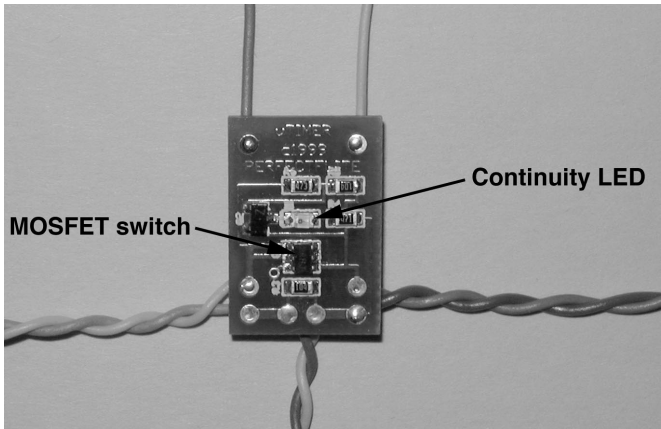

Setting the Delay

The delay for your timer is adjustable from 1 to 16 seconds in 1 second intervals by cutting jumper traces J0 through J3. Make sure that the trace is completely cut through – making two adjacent cuts and removing a small section of the trace is the most reliable way of accomplishing this. If you have a multimeter you can use its Ohms or Continuity function to verify that the cut traces are open-circuit.



If you decide to change the delay in the future and need to restore the continuity of a cut trace, simply solder a small section of wire between the proper solder pads.

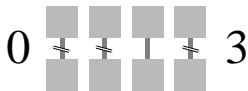

Pads 0, 1, 3 cut.
Delay = 12 sec.

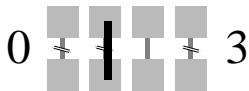

Pad 1 restored.
Delay=10 sec.

Table of Delay vs. Jumpers

J0	J1	J2	J3	Seconds	J0	J1	J2	J3	Seconds
0	0	0	0	1	0	0	0	1	9
1	0	0	0	2	1	0	0	1	10
0	1	0	0	3	0	1	0	1	11
1	1	0	0	4	1	1	0	1	12
0	0	1	0	5	0	0	1	1	13
1	0	1	0	6	1	0	1	1	14
0	1	1	0	7	0	1	1	1	15
1	1	1	0	8	1	1	1	1	16

Legend:

1=cut trace, 0=leave trace

Connections

The following illustration depicts the proper wiring of the microTimer, battery, igniter, and switches.

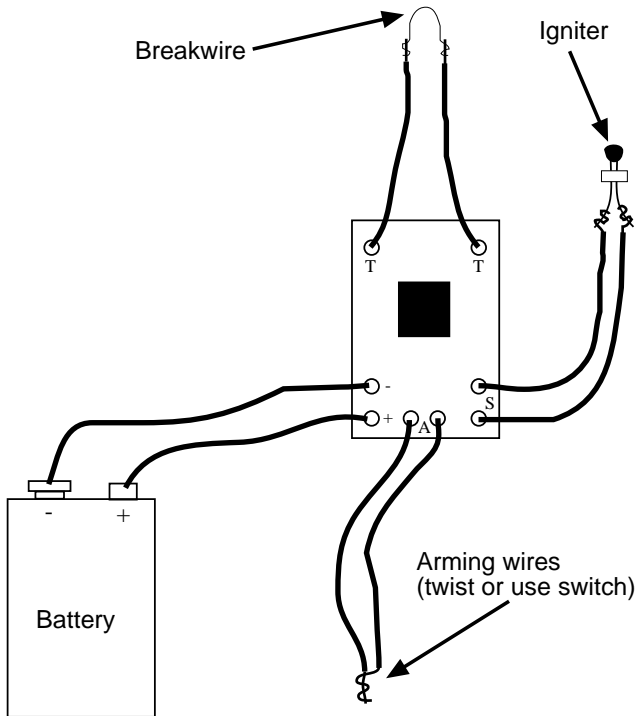

Installation

After setting the proper delay, install the timer in the rocket by gluing it to the inner wall of the airframe. If you first drill a small hole in the airframe and align it with the continuity LED on the bottom of the board you will be able to check continuity from outside the rocket. Similarly, the arming “switch” can consist of the arming leads run out through a hole in the airframe – just twist, tape, and stuff back through the hole before launching.

Try to keep the wiring lengths to a minimum to reduce voltage drops due to wiring resistance. The battery should be mounted as far forward as possible for least impact on the CP/CG relationship. Make sure that the timer, battery, and wiring do not interfere with the proper deployment of the recovery devices.

Always test a new installation before launching. Set up the timer normally, substituting a dummy load such as a light bulb for the igniter. Run through the checklist and confirm that the delay is as desired and that the bulb comes on at the end of the time interval. Testing with an igniter of the type that will be used in the real application (but *not* installed in an engine or ejection charge) will confirm that the battery has enough power to fire the igniter.

Checklist

- Insure that power is OFF or battery is disconnected.
- Turn OFF arming switch or disconnect arming leads.
- Connect igniter or ejection system to igniter leads from timer.
- Connect breakwire or pull-pin.
- Turn ON power/connect battery.
- Turn ON arming switch/connect arming leads together.
- Launch!

Cautions

- Do not touch circuit board traces or components or allow metallic objects to touch them when the timer is powered on. This could cause damage to your timer or lead to premature ejection charge or staged motor ignition.
- Exercise caution when handling live ejection charges - they should be considered to be explosive devices and can cause injury or damage if handled improperly.
- Do not allow the timer to get wet. Only operate the timer within the environmental limits listed in the specifications section.
- Check battery voltage and polarity before connecting to the timer.
- Always follow proper operational sequencing as listed in preflight checklist.

Appendix

Igniter Sources:

Estes Industries. *EST2301*

Igniter

1295 H Street

Penrose, CO 81240

Countdown Hobbies (dealer)

7 P.T.Barnum Sq.

Bethel, CT 06801-1838

(203)790-9010

www.countdownhobbies.com

Luna Tech *Oxral*
148 Moon Drive
Owens Cross Roads, AL 35763
(256) 725-4224
www.pyropak.com

Daveyfire *Daveyfire*
7311 Greenhaven Drive, Suite 100
Sacramento, CA 95831-3572
(916) 391-2674

Performance Hobbies (dealer)
442 Jefferson Street NW
Washington, DC 20011-3126
(202) 723-8257
www.performancehobbies.com

Specifications

microTimer

dimensions: 0.55"W x 0.80"L x 0.19"T
weight: 4 grams
operating voltage: 3.4V to 9.6V
firing current: 5A for 100ms, 2.5A for 1000ms
continuity check current: 100 μ A max.
trigger: normally-closed switch or breakwire
timing range: 1 second to 16 seconds
timing accuracy: +/- 6% typical
operating temperature: 0C to 70C

Warranty

All *assembled* Perfectflite products include a full three year/36 month warranty against defects in parts and workmanship. All Perfectflite *kits* include a full three year/36 month warranty against defects in factory-supplied parts. Should your Perfectflite product fail during this period, call or email our Customer Service department for an RMA number and information about returning your product. The warranty applies to the timer only, and does not cover the rocket, motor, or other equipment. This warranty does not cover damage due to misuse, abuse, alteration, or operation outside of the recommended operating conditions included with your product.

Liability

Due care has been employed in the design and construction of this product so as to minimize the dangers inherent in its use. As the installation, setup, preparation, maintenance, and use of this equipment is beyond the control of the manufacturer, the purchaser and user accept sole responsibility for the safe and proper use of this product. The principals, employees, and vendors of the manufacturer shall not be held liable for any damage or claims resulting from any application of this product. If the purchaser and user are not confident in their ability to use the product in a safe manner it should be returned to the point of purchase immediately. Any use of this product signifies acceptance of the above terms by the purchaser and user.

Caution! Read and understand before using!

Igniter selection for use with the microTimer

Make sure that the igniter that you use does not exceed the maximum current capability of the timer as listed in the specifications section of the manual. When used with an appropriate voltage battery, low current e-matches and Estes igniters work fine. If in doubt, measure the resistance of the igniter in question and calculate its current requirements with the voltage you will be using ($I=E/R$). For example:

Resistance = 2Ω , Voltage = 3.6V (3 cell NiCad) then:

Current = $3.6V/2\Omega$ or 1.8A (within spec).

(Daveyfires and Estes igniters work great on 3.6V)

Using a 9V battery with the same igniter:

Current = $9V/2\Omega$ or 4.5A (borderline overload)

Using a 9V battery with a 1Ω igniter:

Current = $9V/1\Omega$ or 9A (POW!)

Using a 9V battery with a 4Ω igniter:

Current = $9V/4\Omega$ or 2.25A (within spec)

Do NOT short-circuit the igniter leads at any time! Excessive current will flow if the timer is triggered, potentially destroying the FET switch. (If you do toast it, we can fix it - give us a call.)

Caution! Read and understand before using!